

4x ϕ 5.3 (inkl. 4x Schraube M6x20 gewindefurchend)
 4x ϕ 5.3 (incl. 4x Screw M6x20 self-tapping)

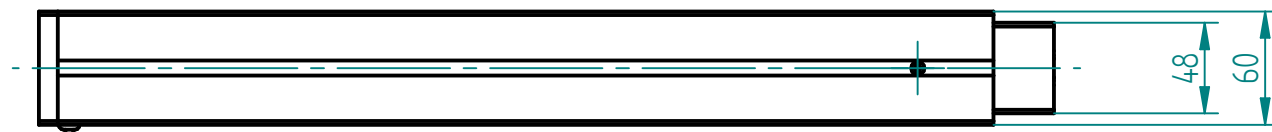

Schlauch 4m vormontiert
 Tubing 4m pre-mounted

ausgefahren
 extended

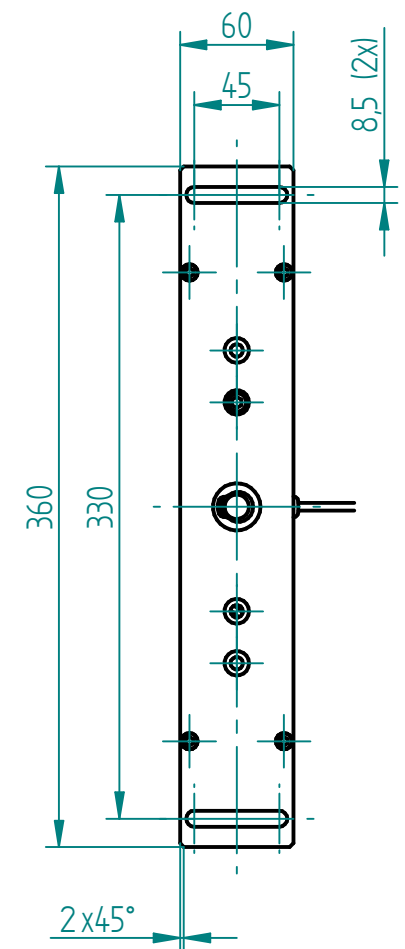
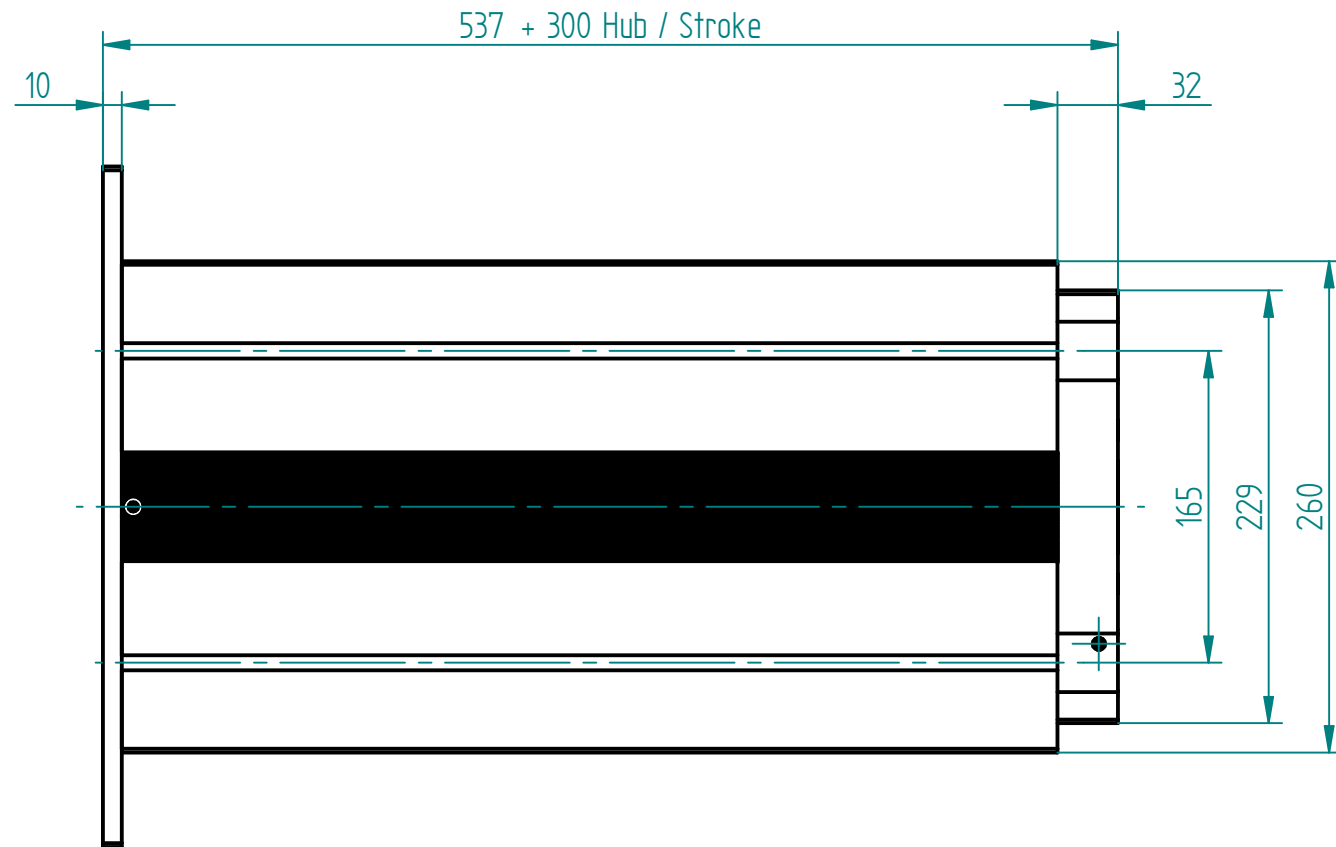
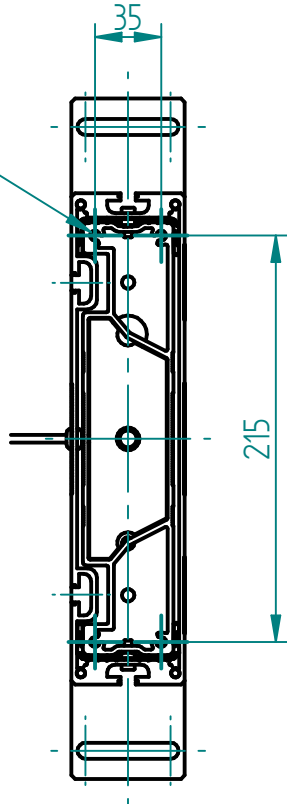
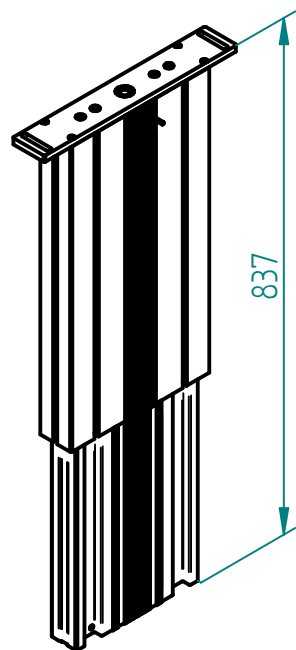

eingefahren
 retracted

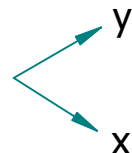
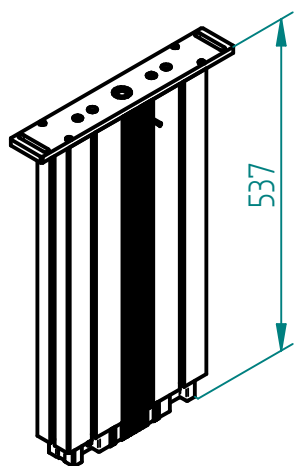

Nutengeometrie
 T-Slot geometry

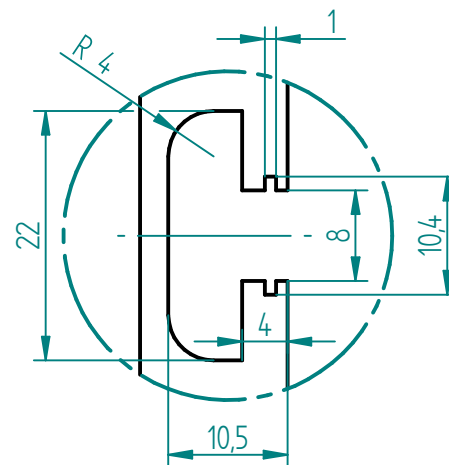

Technische Daten / technical specifications

max. Traglast / max. load	2'500 N
max. Systembelastung / max. system load	abhängig von Pumpe / depending on pump
max. Hub / max. stroke	300 mm
max. stat. Biegemoment / max. static bending moment	Mbx stat. 1'200 Nm / Mby stat. 450 Nm
max. dyn. Biegemoment / max. dynamic bending moment	Mbx dyn. 550 Nm / Mby dyn. 200 Nm
Aluminiumprofile / aluminium profiles	farblos eloxiert / colorless anodized
Führungsart / type of guidance	Gleitführung (Kunststoff) / slide (plastics)

06	22.06.2022	tiho	1184: Innenprofil neu ohne mittlere Bohrungsreihe, nur Eckbohrungen
05	11.09.2019	tiho	1086: Zylinderhalter an Innenprofil angepasst
04	26.03.2019	tiho	1050: Innenprofil neu ohne T-Nut, Bohrbild mit Eckbohrungen
03	23.03.2018	bm	0995: Bohrabstände neu 110.5 & 165.5, alt 110 & 165
02	02.05.2017	bm	0940: Neue Adapterplatte mit Langloch
01	08.02.2017	th	0924: Kabeltülle (124.00004) ersetzt durch Kabeltülle (124.00123)

Index	Datum / Date	Name	Änderungsmitteilung / notification of change
GEZEICHNET / DRAWN	09.03.2016	tiho	GEWICHT / WEIGHT 7.925 kg
GEPRÜFT / CHECKED	09.03.2016	anhe	MAßSTAB / SCALE 1:4
ERGO SWISS table lift systems		ZEICHNUNGSNUMMER / DRAWING NUMBER a-306.00629	ARTIKELNUMMER / ASSEMBLY NUMBER 306.00629
			BEZEICHNUNG / ASSEMBLY NAME Tischbein TL 1830 Table leg TL 1830
			INDEX 06
			FORMAT A3